

eMachines E627 Series

Quick Guide

Copyright © 2009. Acer Incorporated.
All Rights Reserved.

eMachines E627 Series Quick Guide
Original Issue: 06/2009

Changes may be made periodically to the information in this publication without obligation to notify any person of such revisions or changes. Such changes will be incorporated in new editions of this manual or supplementary documents and publications.

Record the model number, serial number, purchase date and place of purchase information in the space provided below. The serial number and model number are recorded on the label affixed to your computer. All correspondence concerning your unit should include the serial number, model number and purchase information.

This booklet has been reviewed for accuracy. Although Acer makes all reasonable attempts for this booklet to be printed in an accurate manner, Acer takes no responsibility for any inadvertent errors or misprints. Acer's liability with respect to this booklet is subject to any limitation of liability set out in the applicable product warranty.

No part of this publication may be reproduced, stored in a retrieval system, or transmitted, in any form or by any means, electronically, mechanically, by photocopy, recording or otherwise, without the prior written permission of Acer Incorporated.

eMachines E627 Series Notebook PC

Model number: _____

Serial number: _____

Date of purchase: _____

Place of purchase: _____

eMachines and the eMachines logo are registered trademarks of Acer Incorporated. Other companies' product names or trademarks are used herein for identification purposes only and belong to their respective companies.

First things first

We would like to thank you for making an eMachines notebook your choice for meeting your mobile computing needs.

Your guides

To help you use your eMachines notebook, we have designed a set of guides:

First off, the **Just for Starters...** poster helps you get started with setting up your computer.

The **eMachines Generic User Guide** contains useful information applying to all models in the eMachines product series. It covers basic topics such as eMachines Recovery Management, using the keyboard, audio, etc. Please understand that due to its nature, the **Generic User Guide** as well as the **eMachinesSystem User Guide** mentioned below will occasionally refer to functions or features which are only contained in certain models of the series, but not necessarily in the model you purchased. Such instances are marked in the text with language such as "only for certain models".

The **Quick Guide** introduces you to the basic features and functions of your new computer. For more on how your computer can help you to be more productive, please refer to the **eMachinesSystem User Guide**. This guide contains detailed information on such subjects as system utilities, data recovery, expansion options and troubleshooting. In addition it contains warranty information and the general regulations and safety notices for your notebook. It is available in Portable Document Format (PDF) and comes preloaded on your notebook. Follow these steps to access it:

- 1 Click on  **Start, All Programs, eMachinesSystem.**
- 2 Click on **eMachinesSystem User Guide.**



Note: Viewing the file requires Adobe Reader. If Adobe Reader is not installed on your computer, clicking on **eMachinesSystem User Guide** will run the Adobe Reader setup program first. Follow the instructions on the screen to complete the installation. For instructions on how to use Adobe Reader, access the **Help and Support** menu.





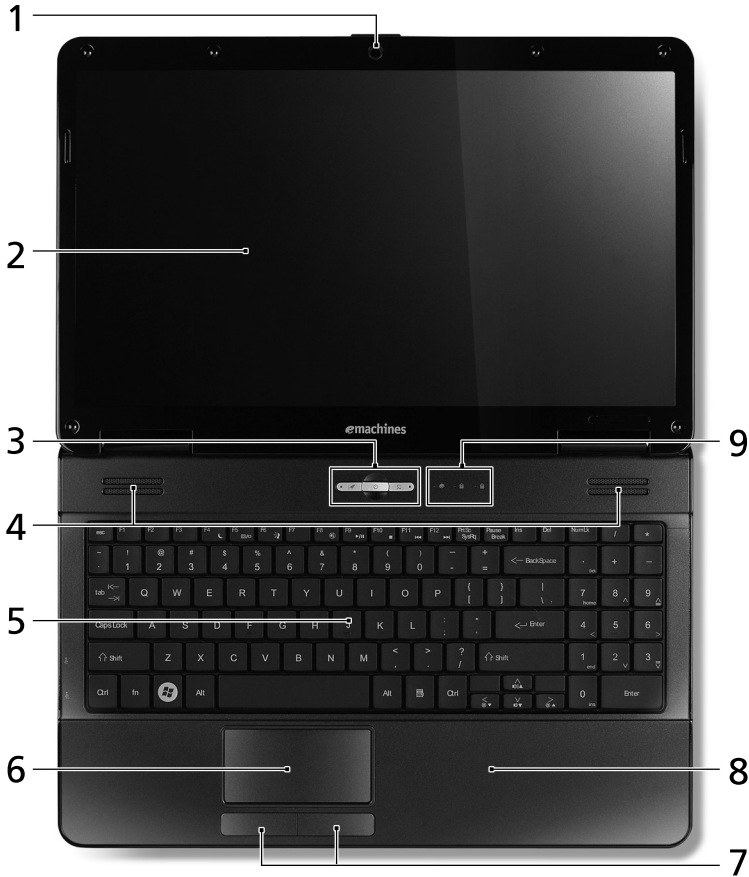

Your eMachines notebook tour

After setting up your computer as illustrated in the **Just for Starters...** poster, let us show you around your new eMachines notebook.

Top view





#	Icon	Item	Description
1		Integrated webcam	Web camera for video communication. (only for certain models)





#	Icon	Item	Description
2		Display screen	Also called Liquid-Crystal Display (LCD), displays computer output.
3		Touchpad toggle	Turns the internal touchpad on and off.
		Power button	Turns the computer on and off.
		Wireless LAN communication button/indicator	Enables/disables the wireless LAN function. Indicates the status of wireless LAN communication.
4		Speakers	Left and right speakers deliver stereo audio output.
5		Keyboard	For entering data into your computer.
6		Touchpad	Touch-sensitive pointing device which functions like a computer mouse.
7		Click buttons (left and right)	The left and right buttons function like the left and right mouse buttons.
8		Palmrest	Comfortable support area for your hands when you use the computer.
9		HDD	Indicates when the hard disk drive is active.
		Num Lock	Lights up when Num Lock is activated.
		Caps Lock	Lights up when Caps Lock is activated.

Hotkeys

The computer employs hotkeys or key combinations to access most of the computer's controls like screen brightness and volume output.



To activate hotkeys, press and hold the **<Fn>** key before pressing the other key in the hotkey combination.

Hotkey	Icon	Function	Description
<Fn> + <F4>		Sleep	Puts the computer in Sleep mode.
<Fn> + <F5>		Display toggle	Switches display output between the display screen, external monitor (if connected) and both.
<Fn> + <F6>		Screen blank	Turns the display screen backlight off to save power. Press any key to return.

Hotkey	Icon	Function	Description
<Fn> + <F8>		Speaker toggle	Turns the speakers on and off.
<Fn> + <Δ>		Volume up	Increases the sound volume.
<Fn> + <∇>		Volume down	Decreases the sound volume.
<Fn> + <Δ>		Brightness up	Increases the screen brightness.
<Fn> + <∇>		Brightness down	Decreases the screen brightness.

Closed front view



#	Item	Description
1	 Power ¹	Indicates the computer's power status.
	 Battery ¹	Indicates the computer's battery status. 1. Charging: The light shows amber when the battery is charging. 2. Fully charged: The light shows blue when in AC mode.
2	 Multi-in-1 card reader	Accepts Secure Digital (SD), MultiMediaCard (MMC), Memory Stick (MS), Memory Stick PRO (MS PRO), xD-Picture Card (xD). Note: Push to remove/install the card. Only one card can operate at any given time.

1. The front panel indicators are visible even when the computer cover is closed up.







Rear view

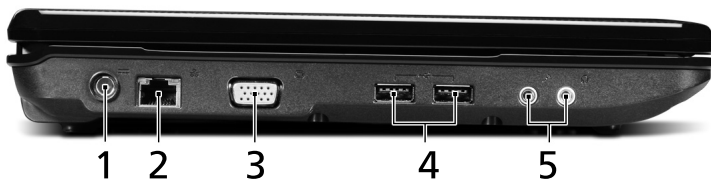

#	Item	Description
1	Ventilation slots	Enable the computer to stay cool, even after prolonged use.

Left view



#	Icon	Item	Description
1		DC-in jack	Connects to an AC adapter.
2		Ethernet (RJ-45) port	Connects to an Ethernet 10/100-based network.
3		External display (VGA) port	Connects to a display device (e.g., external monitor, LCD projector).
4		USB 2.0 port	Connect to USB 2.0 devices (e.g., USB mouse, USB camera).
5		Microphone-in jack	Accepts inputs from external microphones.
		Headphones/speaker/line-out jack	Connects to audio line-out devices (e.g., speakers, headphones).

Right view

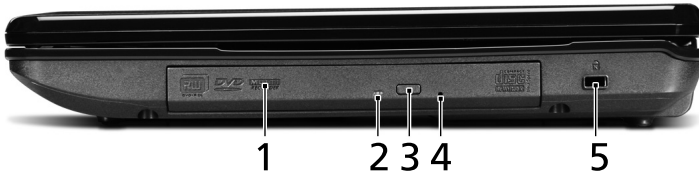



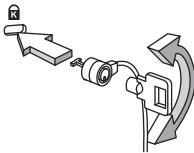

#	Icon	Item	Description
1		Optical drive	Internal optical drive; accepts CDs or DVDs.
2		Optical disk access indicator	Lights up when the optical drive is active.
3		Optical drive eject button	Ejects the optical disk from the drive.
4		Emergency eject hole	Ejects the optical drive tray when the computer is turned off. Note: Insert a paper clip to the emergency eject hole to eject the optical drive tray when the computer is off.
5		Kensington lock slot	Connects to a Kensington-compatible computer security lock. Note: Wrap the computer security lock cable around an immovable object such as a table or handle of a locked drawer. Insert the lock into the notch and turn the key to secure the lock. Some keyless models are also available.

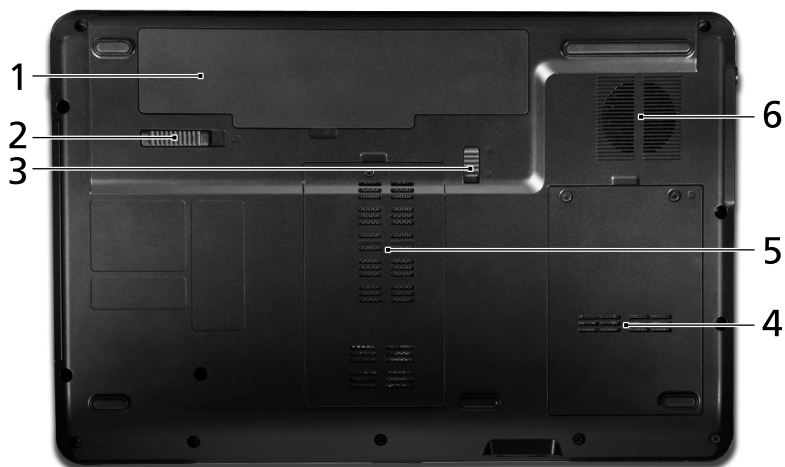

Base view



#	Icon	Item	Description
1		Battery bay	Houses the computer's battery pack.
2		Battery release latch	Releases the battery for removal.
3		Battery lock	Locks the battery in position.
4		Hard disk bay	Houses the computer's hard disk (secured with screws).
5		Memory compartment	Houses the computer's main memory.
6		Ventilation slots and cooling fan	Enable the computer to stay cool, even after prolonged use. Note: Do not cover or obstruct the opening of the fan.

Specifications

Operating system	<ul style="list-style-type: none"> Genuine Windows Vista®
Platform	<ul style="list-style-type: none"> AMD Better By Design Program, featuring: <ul style="list-style-type: none"> AMD Athlon™ 64 X2 dual-core processor* AMD Athlon™ 64 single-core processor* AMD M780G Chipset IEEE 802.11b/g
System memory	<ul style="list-style-type: none"> Dual-channel support Up to 2 GB of DDR2 667 MHz memory, upgradeable to 4 GB using two soDIMM modules
Display	<ul style="list-style-type: none"> 15.6" HD 1366 x 768 16:9 aspect ratio
Graphics	<ul style="list-style-type: none"> ATI Radeon™ HD 3200 Graphics
Storage subsystem	<ul style="list-style-type: none"> 2.5" hard disk drive DVD-Super Multi double-layer drive Multi-in-1 card reader
Audio	<ul style="list-style-type: none"> Two built-in stereo speakers High-definition audio support MS-Sound compatible
Communication	<ul style="list-style-type: none"> Integrated webcam* WLAN: IEEE 802.11b/g LAN: Fast Ethernet; Wake-on-LAN ready
Dimensions	<ul style="list-style-type: none"> 372.3 (W) x 246.5 (D) x 26.8/39.6 (H) mm (14.4 x 10.8 x 1.1/1.5 inches) 2.7 kg (6.0 lbs.) with 6-cell battery pack
Privacy control	<ul style="list-style-type: none"> BIOS user, supervisor, HDD passwords Kensington lock slot
Power subsystem	<ul style="list-style-type: none"> ACPI 3.0 48.8 W 4400 mAh 3-pin 65 W AC adapter ENERGY STAR® 4.0*
Special keys and controls	<ul style="list-style-type: none"> 99-/100-/103-key keyboard Touchpad pointing device

I/O interface	<ul style="list-style-type: none">• Multi-in-1 card reader (SD™, MMC, MS, MS PRO, xD)• USB 2.0 port• External display (VGA) port• Headphones/speaker/line-out jack• Microphone-in jack• Ethernet (RJ-45) port• DC-in jack for AC adapter
Environment	<ul style="list-style-type: none">• Temperature:<ul style="list-style-type: none">• Operating: 5 °C to 35 °C• Non-operating: -20 °C to 65 °C• Humidity (non-condensing):<ul style="list-style-type: none">• Operating: 20% to 80%• Non-operating: 20% to 80%



.....

Note: * Only for certain models.



.....

Note: The specifications listed above are for reference only. The exact configuration of your PC depends on the model purchased.